

ITC
EN ISO 140
parti 1-2-3-4-5

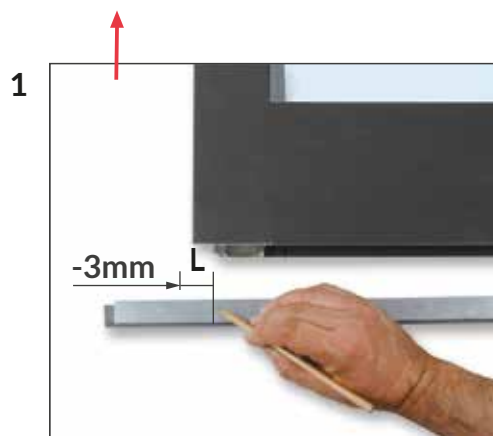

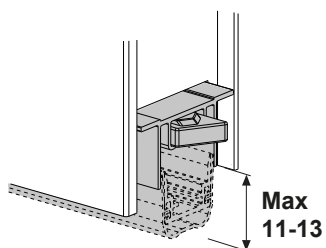

3

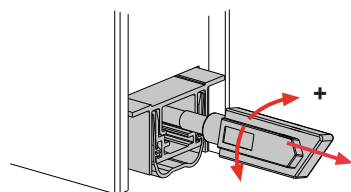
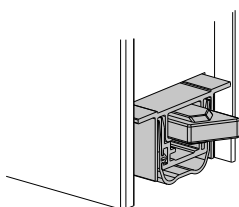
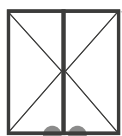
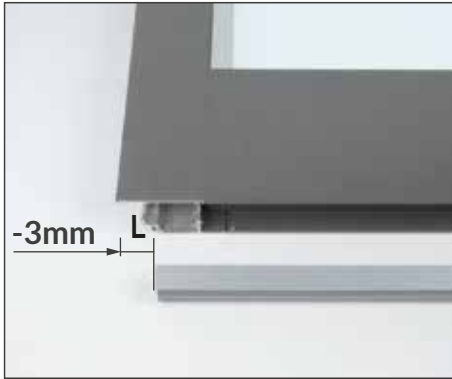

4



5

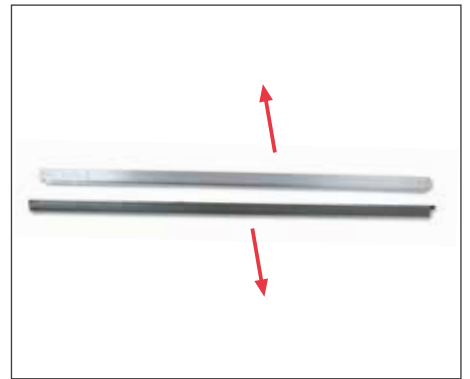

6



7

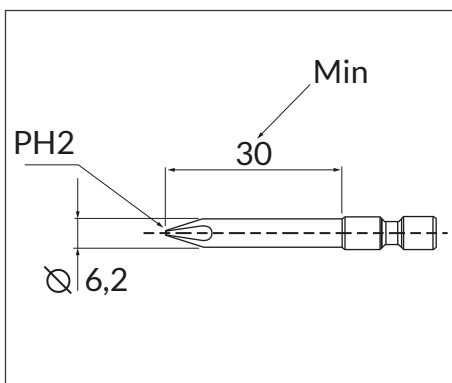

8



9



10



11

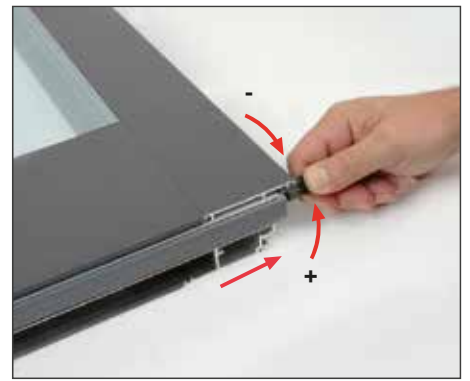

12

