

IT EN FR ES

**OLTRE**

Istruzioni di montaggio per maniglione antipanico Oltre  
 Assembly instructions for Oltre tubular exit panic device  
 Instructions d'assemblage pour antipanique tubulaire Oltre  
 Instrucciones de montaje para antipanico tubular Oltre

**fapim**<sup>®</sup>

Life in evolution

ULAC - Rev.03

Codice di certificazione  
 Certification code  
 Code de certification  
 Código de certificación

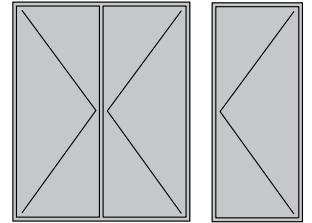
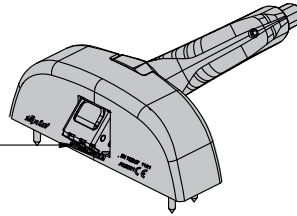

Certificazione prodotto n°  
 Product certification no.  
 Certification produit n°  
 Certificación de producto n°



1488-CPR-0069/W  
 1488-CPR-0070/W

**CE** 18  
 0497

**019 - DoP - CPR - 2018**

**018 - DoP - CPR - 2018**

**EN 1125:2008**



Sostanze pericolose: nessuna  
 Dangerous materials: none  
 Sustances dangereuses: neant  
 Sustancias peligrosa: ninguna

3	7	7	A	1	4	2	2	A	A
---	---	---	---	---	---	---	---	---	---



Categoría d'uso Category of use Catégorie d'utilisation Categoría de uso	Durata massima: 200.000 aperture Maximum life: 200.000 openings Durée maximale: 200.000 ouvertures Duración máxima: 200000 aberturas	Peso della porta classe massima: oltre 200 kg Door mass maximum class: more than 200 kg Poids de la porte classe maximale: plus de 200 kg Peso de la puerta clase máxima: más de 200 kg	Idoneo resistenza fumo Suitable smoke resistance Apte résistance feu Idóneo resistencia humo	O	Non idoneo fuoco/fumo Not suitable fire/smoke Pas apte feu/fumage No idóneo resistencia al fuego/humo	Sicurezza per le persone Safety for the persons Sûreté pour les individus Seguridad para las personas	Resistenza alla corrosione altissima: 240 h a nebbia salina neutra High resistance to the corrosion: 240 h to the neutral salt spray Résistance à la corrosion très élevée: 240 h au brouillard salin neutre Altísima resistencia a la corrosión: 240 h a niebla salina neutral	Sicurezza per i beni Safety for the goods Sûreté pour les biens Seguridad para los bienes	Sporgenza della barra minima: inferiore a 100 mm Minimum projection of the bar: lower than 100 mm Saillie de la barre minimale: inférieure à 100 mm Sobresalida de la barra mínima: inferior a los 100 mm	Azionamento con barra a spinta Operated by pushing bar Accionamiento con barra a empujar	Campo di applicazione della porta (anta singola/anta doppia) Door application range (single wing/double wing) Champ d'application de la porte (1 vantail/deux vantaux) Campo de aplicación de la puerta (hoja individual/hoja doble)
			Idoneo resistenza al fuoco Suitable for fire resistance Apte pour la résistance au feu Idóneo resistencia al fuego								

Gli articoli conformi ai requisiti della norma EN 1125:2008 sono individuabili dai simboli

Articles complying with the requirements of standard EN 1125:2008 are identifiable by the symbols

Les articles conformes aux attributs demandés par la norme EN 1125:2008 sont reconnaissables grâce aux symboles

Los artículos que cumplen la norma EN 1125:2008 se identifican con los símbolos

3	7	7	B	1	4	2	2	A	A
---	---	---	---	---	---	---	---	---	---



**fapim**<sup>®</sup>

Life in evolution

**IT - IMPORTANTE**

Le caratteristiche di questo prodotto rivestono la massima importanza per la sicurezza delle persone.

Non e' consentito apportare al prodotto modifiche o eseguire un montaggio diverso da quello descritto in queste istruzioni.

**1 - Campo di applicazione**

Il campo di applicazione di questo maniglione antipanico e' limitato come segue:

Massimo peso della porta	Massima altezza della porta	Massima larghezza della porta	Temperature limite di funzionamento
300 Kg	2.520 mm	1.320 mm	- 10° C / +60°C

La larghezza efficace della barra di azionamento quota X, deve essere quanto piu' possibile prossima alla luce di passaggio della porta, quota Y, in ogni caso, mai meno del 60% di essa. Questo maniglione non è adattabile alle porte senza battuta (va e vieni). Il maniglione deve essere montato in modo che la barra risulti ad una altezza dal pavimento compresa tra 900 e 1100 mm. Dove la maggioranza degli occupanti è rappresentata da bambini, occorre considerare la possibilità di ridurre l'altezza della barra

**2 - Raccomandazioni per l'installazione ed il montaggio**

- Il maniglione antipanico prodotto in conformita' alla EN 1125:2008 da' un alto grado di sicurezza per le persone ed una ragionevole sicurezza per le cose, se è installato su porte e telai in buone condizioni.

- Si deve controllare che la porta sia montata in modo corretto e non incontri ostacoli nel movimento.

- Si deve porre attenzione affinché le guarnizioni di tenuta montate sulla porta completa non impediscano il corretto funzionamento del maniglione antipanico.

- Prima di montare il maniglione antipanico su una porta tagliafuoco/fumo si deve esaminare la certificazione di resistenza al fuoco per assicurarsi che il maniglione sia adatto a quella particolare porta.

- Su porte a due ante con battute e quando su entrambe le ante siano installati maniglioni antipanico, e' indispensabile controllare che ciascuna anta si apra quando viene azionato il relativo maniglione antipanico e che entrambe le ante si aprano liberamente quando entrambi i maniglioni sono azionati contemporaneamente.

- Durante l'installazione devono essere seguite scrupolosamente le istruzioni di montaggio. Le istruzioni per il montaggio e la manutenzione devono essere consegnate dall'installatore all'utilizzatore.

- Gli elementi di chiusura e le bocchette devono essere installati in modo da impegnarsi fra di loro in maniera sicura. Si deve porre attenzione che la sporgenza degli elementi di chiusura, quando quest'ultimi sono retratti, non impediscano alla porta di ruotare liberamente.

- Quando il maniglione antipanico deve essere montato su porte a due ante con battute e dispositivi di chiusura automatica, deve essere montato un dispositivo di coordinamento della sequenza di chiusura per assicurare la corretta sequenza di chiusura delle porte.

- Il dispositivo non è idoneo per porte con applicazioni ad infilare.

- Per applicazioni su porte in vetro è essenziale che questo sia laminato / temprato.

- Nessun dispositivo che consenta di bloccare la porta nella posizione di chiusura deve essere utilizzato oltre a quelli stabiliti nella presente norma europea. Ciò non preclude

l'installazione di dispositivi di chiusura automatici.



- Un segnale indicante "premere la barra per aprire" od un pittogramma (vedi figura a lato) deve essere posizionato sulla faccia interna della porta immediatamente sopra alla barra d'azionamento o sulla stessa se la sua superficie piatta lo permette.

- Il dispositivo è stato testato per la resistenza al fuoco: la resistenza minima è di 90 minuti.

- Il sistema di fissaggio rispetta i requisiti normativi del paragrafo 4.3 EN 1125:2008 (riferimento rapporto di prova SRP01713).

- Se un dispositivo per la chiusura delle porte deve essere usato per riportare la porta nella posizione di chiusura, si deve fare attenzione a non rendere difficile l'uso dell'uscita a giovani bambini, anziani ed infermi.

- Tutte le bocchette o le piastre di protezione eventualmente fornite devono essere installate per assicurare la conformita' alla EN 1125:2008.

- La validita' della certificazione decade quando l'esemplare: - e' stato danneggiato; - e' stato sottoposto ad incendio che ne puo' aver alterato le proprieta' accertate; - non corrisponde piu' alla documentazione depositata (es. modifiche e/o alterazione da parte di terzi).

- FAPIM s.p.a. e' responsabile solo ed esclusivamente se il dispositivo antipanico installato e' composto solo da articoli Fapim OLTRE.

**3 - Raccomandazioni per la manutenzione**

Si raccomanda agli occupanti o ai loro rappresentanti autorizzati, di eseguire i seguenti controlli di manutenzione almeno due volte/anno; l'installatore e/o l'utilizzatore, anche in riferimento a quanto prescritto nell' art. 4 del decreto ministeriale del 03/11/2004 per la sicurezza in caso di incendio, devono registrare le operazioni effettuate nella tabella seguente:

A) Controllare ed azionare il maniglione antipanico e assicurarsi che tutti i componenti siano in soddisfacenti condizioni di funzionamento. In particolare controllare che le viti di fissaggio siano ben serrate.

B) Controllare che la bocchetta o le bocchette siano libere da ostruzioni.

C) Controllare che le superfici di contatto degli scrocchi e delle bocchette siano ben lubrificate. Se necessario lubrificare con grasso del tipo TecnoLube Seal SYNTHY HTL GREASE 5500 o altro equivalente che abbia temperatura d'impiego e viscosità adeguate alle condizioni di utilizzo.

D) verificare che non esistano dispositivi di chiusura aggiuntivi rispetto all'installazione originale;

E) controllare periodicamente che tutti i componenti del sistema siano ancora corretti in accordo all'elenco dei componenti forniti originariamente;

F) controllare periodicamente che l'elemento operativo sia serrato correttamente e, usando un dispositivo di misura, verificare la forza necessaria per l'apertura della porta. Verificare che le forze d'azionamento non siano variate in modo significativo rispetto a quelle registrate dopo la prima installazione.

È possibile scaricare la dichiarazione di prestazione – DoP - alla pagina web [www.fapim.it](http://www.fapim.it) nella apposita sezione "certificazioni di prodotto".

È possibile scaricare il registro di installazione e manutenzione del dispositivo antipanico nella sezione "catalogo" del sito web [www.fapim.it](http://www.fapim.it) cercando i codici dei prodotti serrature centrali.

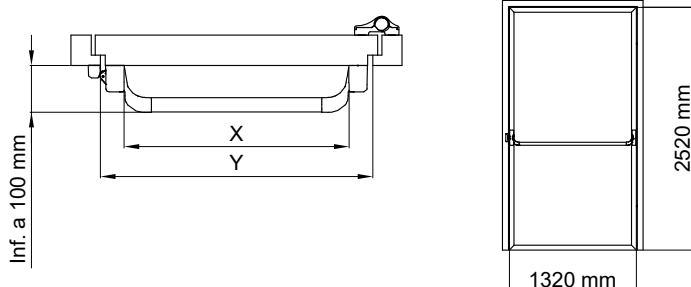



## EN - IMPORTANT

The features of this product are of the utmost importance for the safety of people.

It is not permitted to carry out any modifications to the product, and no assembly other than the one described herein is allowed.

### 1 – Field of application

The field of application of this panic bolt is limited as follows:

Maximum mass of the door	Maximum height of the door	Maximum length of the door	Minimum and maximum working temperatures
300 Kg	2.520 mm	1.320 mm	- 10° C / +60°C

The effective width of the activation bar X, shall be as close as possible to the door opening Y, yet not less than 60% of it. This panic bolt cannot be fitted on swing doors. The panic bolt must be assembled in a way as to keep the bar between 900 and 1100 mm from the floor. If most users are children, consider the possibility to reduce the height of the bar.

### 2 – Recommendations for the correct installation and assembly

- The panic bolt is manufactured in conformity to the EN 1125:2008 standards. High safety degree for both people and things is ensured if it is installed on doors and frames in good conditions.
- Make sure that the door has been properly installed and that there is no hindrance to its movement.
- Make sure that the seals fitted on the complete doors do not affect the correct working of the panic bolt.
- Prior to assembling the panic bolt on a fire/stop door, check the fire resistance certification to make sure that the panic bolt is suitable for use on that particular door.
- In case of double doors, when a panic bolt is installed on both wings, make sure that each wing opens when the panic bolt is operated and that both wings open freely when the two panic bolts are operated simultaneously.
- Follow the assembly instructions scrupulously during installation. The maintenance and assembly instructions must be delivered to the user by the installer.
- Locking elements and vents must be installed in such a way as to safely engage to each other. Make sure that the projection of the locking elements, when they are in the retracted position, do not affect the free rotation of the door.
- In case of panic bolt assembly on double doors with automatic locking devices, a locking sequence coordinator must be installed to ensure that the locking sequence is carried out in the right way.
- The device is not suitable for installation on doors with slip-in applications.
- Application on glazed doors is possible, provided the glass is of laminated / tempered type.
- No device allowing the door to be locked in the closing position shall be used, except those reported in this European Standard. This does not prevent automatic safety locking devices from being installed.



- A notice "press bar to open" or a drawing (see the side picture) must be placed on the internal side of the door, over the operating bar or on the bar itself if possible.

- The device has been tested to fire resistance: minimum resistance is 90 minutes.
- The fastening system complies with the standard requirements of § 4.3 EN 1125:2008 (see test report SRP01713).
- If a door locking device must be used to bring the door back in its closed position, make sure to guarantee an easy exit to children, old and invalid people.
- All vents or protection plates, if supplied, must be fitted to ensure the compliance with the EN 1125:2008 standard.
- Certification decays if the device: - has been damaged; - has been exposed to fire which may have altered its ascertained properties; - no longer corresponds to the registered documentation (e.g. modifications or alterations by third parties).
- FAPIM spa is responsible solely and exclusively if the panic device installed is made up of Fapim OLTRE components only.

### 3 – Recommendations for maintenance

Users or their authorized representatives are recommended to carry out the following maintenance checks at least twice a year; installer and/or user, with respect to the prescriptions mentioned in art. 4 of the Ministerial Decree of 03/11/2004 for fire safety, are requested to register the operations carried out in the following table:

- Check and operate the panic bolt and make sure that all the components are in good working conditions. Make sure that the fixing screws are securely tightened.
- Check that the vent or vents are free from obstructions.
- Check that the contact surfaces of the latch bolts and of the vents are well lubricated. If necessary, lubricate with TecnoLube Seal SYNTHY HTL GREASE 5500 grease type or other equivalent having an operating temperature and viscosity suitable for the conditions of use.
- Check that no locking devices have been installed in addition to the original configuration;
- Check periodically that all system components are still those specified in the list of components initially supplied;
- Check periodically that the operating element is correctly secured and, by means of a measuring device, verify the strength required to open the door. Check that the operating force has not considerably changed with respect to the first installation.

You can download the Declaration of Performance – DoP – from the webpage [www.fapim.it](http://www.fapim.it) in the appropriate "Product Certification" section.

You can download the register of installation and maintenance of the panic device in the "Catalogue" section of the website [www.fapim.it](http://www.fapim.it) seeking the item codes of the central locks.

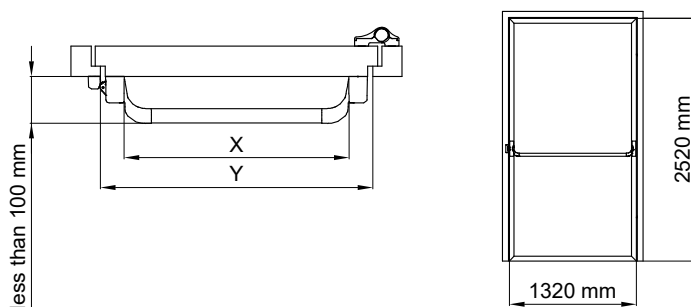



## FR - IMPORTANT

Les caractéristiques de ce produit sont très importantes pour la sécurité des personnes. Aucune modification du produit ou montage différent de celui décrit dans cette notice, n'est autorisé.

## 1 - Champ d'application

Les limites de champ d'application de cette antipanique sont les suivantes :

Poids maximum de la porte	Hauteur maximum de la porte	Largeur maximum de la porte	Températures limites de fonctionnement
300 Kg	2.520 mm	1.320 mm	- 10° C / +60°C

La largeur efficace de la barre de manoeuvre, cote X, doit être la plus proche possible au clair de baie de la porte, cote Y, en tout cas jamais inférieur à 60% de celui-ci. Cette antipanique n'est pas adaptable aux portes sans battement (va et vient). L'antipanique doit être montée de manière à ce que la barre de poussée se situe à un niveau du plancher compris entre 900 et 1100 mm. Dans le cas où la majorité des occupants est constitué d'enfants, il faut considérer la possibilité de réduire la hauteur de la barre de poussée.

## 2 – Recommandations pour l'installation et le montage

- L'antipanique produit en conformité avec la norme EN 1125:2008 garantit un haut niveau de sécurité pour les personnes et une bonne sécurité des biens, si elle est installée sur des portes et châssis dans de bonnes conditions.
- Il faut vérifier que la porte est assemblée correctement et qu'il n'y a pas d'obstacles lors de son ouverture.
- Il faut s'assurer que les joints d'étanchéité montés sur la porte complète n'empêchent pas le bon fonctionnement de l'antipanique.
- Avant de monter l'antipanique sur un porte coupe-feu, il faut examiner la certification de résistance au feu pour s'assurer que l'antipanique soit adaptée à cette porte particulière.
- Lorsque des antipaniques sont installées sur les 2 vantaux d'une porte avec battement, il est indispensable de vérifier que chaque vantail s'ouvre indépendamment quand l'antipanique correspondante est actionnée et que les deux vantaux s'ouvrent librement quand les deux antipaniques sont actionnées simultanément.
- Il faut suivre scrupuleusement Les instructions de montage lors de l'installation. Les instructions de montage et d'entretien doivent être livrées par l'installateur à l'utilisateur.
- Les éléments de fermeture et les gâches doivent être installés de manière à s'engager entre eux de façon sûre. Il faut s'assurer que la saillie des éléments de fermeture, quand ces derniers sont rétractés, n'empêche pas à la porte de tourner librement.
- Quand les antipaniques sont montées sur des portes à deux vantaux à battement munis de dispositifs de fermeture automatique, il est nécessaire d'installer un dispositif de coordination des séquences de fermeture, pour assurer une correcte séquence de fermeture des portes.
- Le dispositif n'est pas adapté aux portes coulissantes.
- Pour application sur portes en verre, il faut que le vitrage soit feuilleté / trempé.
- Aucun dispositif permettant le blocage de la porte en position de fermeture, à l'exception de ceux qui ont été indiqués dans cette norme européenne, ne doit être utilisé. Cela n'exclut pas l'installation de dispositifs automatiques de fermeture.



- Un signal indiquant "appuyer sur la barre pour ouvrir" ou un pictogramme (voir figure à côté) doit être positionné sur la partie interne de la porte ou au-dessus de la barre de poussée ou sur elle-même si sa surface le permet.

- le dispositif a été testé pour la résistance au feu : la résistance minimale est de 90 minutes.
- le système de fixation respecte les prescriptions au paragraphe 4.3 de la norme EN 1125:2008 (référence rapport d'essai SRP01713).
- Si un dispositif de fermeture de porte doit être utilisé pour remettre la porte dans la position de fermeture, il faut s'assurer de ne pas rendre difficile l'utilisation de la sortie aux enfants, aux personnes âgées et aux handicapés.
- Toutes les gâches ou les plaques de protection, si fournies, doivent être installées pour assurer la conformité à la norme EN 1125 :2008.
- La validité de la certification déchoit lorsque l'exemplaire : - a été endommagé ; - a été soumis à un incendie qui peut en avoir altéré les propriétés certifiées ; - ne correspond plus à la documentation déposée (ex. modifications et/ou altérations de la part de tiers).
- FAPIM S.p.A. est responsable exclusivement si l'antipanique installée se compose uniquement d'articles Fapim OLTRE.

## 3 – Recommandations pour l'entretien

Il est recommandé aux occupants du bâtiment, ou à leurs représentants autorisés, d'effectuer les contrôles d'entretien suivants au moins deux fois par an ; l'installateur et/ou l'utilisateur, aussi sous le respect des prescriptions de l'art. 4 du décret ministériel daté 03/11/2004 pour la sécurité contre les incendies, doivent enregistrer les opérations effectuées dans le tableau suivant :

- Contrôler et actionner l'antipanique et s'assurer que tous les composants sont en bon état de fonctionnement. En particulier contrôler quel es vis de fixation sont bien serrées.
- Contrôler que la gâche ou les gâches ne sont pas obstruées.
- Contrôler que les surfaces de contact des pènes et des gâches sont bien lubrifiées. Si nécessaire lubrifier avec de la graisse type Tecnolube Seal SYNTHY HTL GREASE 5500 ou autre équivalente ayant une température d'emploi et une viscosité appropriées aux conditions d'utilisation.
- Vérifier qu'il n'existe pas des dispositifs de fermeture additionnels par rapport à l'installation originale;
- Contrôler périodiquement que tous les composants du système sont encore corrects par rapport à la liste des composants donnée originellement
- Contrôler périodiquement que l'élément opératif est correctement serré et, en utilisant un dispositif de mesure, vérifier la force nécessaire pour l'ouverture de la porte. Vérifier que les forces d'actionnement n'ont pas changé de manière considérable par rapport à celles enregistrées après la première installation.

Vous pouvez télécharger la déclaration de performance – DoP – à la page web [www.fapim.it](http://www.fapim.it) dans la section appropriée "certification de produit".

Vous pouvez télécharger le registre d'installation et d'entretien du dispositif de sécurité dans la section "catalogue" du site web [www.fapim.it](http://www.fapim.it) sous les références des produits serrures centrales.

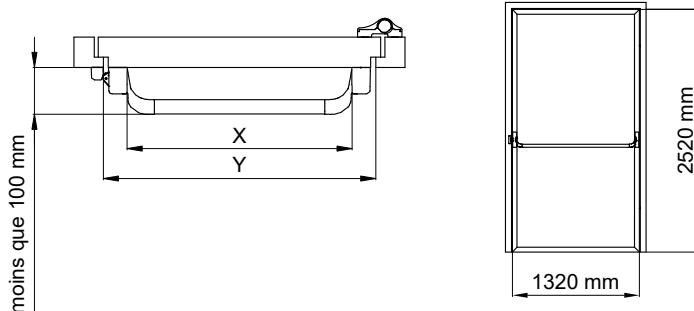



**ES - IMPORTANTE**

Las características de este producto son muy importantes para la seguridad de las personas. No está permitido modificar el producto y/o hacer un montaje que no es lo que está descrito en el papel de instrucciones.

**1 - Campo de aplicación**

El campo di aplicación de este dispositivo anti pánico está limitado según detallado a continuación:

Max, peso de la puerta	Max, altura de la puerta	Max, anchura de la puerta	Temperaturas limite de funcionamiento
300 Kg	2.520 mm	1.320 mm	- 10° C / +60°C

Ancho eficaz de la barra de accionamiento cuota X, tiene que se ser lo más cerca posible a alla luce di passaggio de la puerta, cuota Y, en cada caso, nunca más del 60% de la misma. Este anti pánico no se puede adaptar a las puertas sin batiente (va e vieni). El anti pánico tiene que ser montado de forma tal que la barra resulte ser a una altura del piso incluida entre 900 e 1100 mm. Donde sea que la mayoría de los ocupantes sean niños, hay que considerar de reducir la altura de la barra.

**2 – Advertencias para la instalación y montaje**

- El dispositivo anti pánico fabricado en conformidad con la EN 1125:2008 garantiza seguridad para las personas y una razonable seguridad para los objetos en caso ser montado sobre puertas y marcos que tengan condiciones buenas.
- Hay que controlar que la puerta sea montada correctamente y no encuentre obstáculos en su movimiento.
- Averiguar que todas las guarniciones montada sobre la puerta no impidan el correcto funcionamiento del dispositivo anti pánico.
- Antes de montar el dispositivo anti pánico sobre una puerta corta fuego, hay que examinar su certificación de resistencia al fuego para estar ciertos que en anti pánico se adapte a aquel tipo particular de puerta.
- Sobre puertas de dos hojas con batientes y en caso que los anti pánico estén montados sobre ambas hojas está obligatorio controlar que cada hoja se abra cuando se accione su correspondiente anti pánico y que ambas se abran cuando los dos anti pánicos se accionen al mismo tiempo.
- Durante la instalación hay que respetar en detalle las instrucciones de montaje. Las instrucciones de montaje y la manutención tienen que ser entregadas por al usuario.
- Todos los elementos de cierre tienen que estar montado de forma correcta y segura. Hay que poner la atención que los salientes de los elementos de cierre, cuando estos últimos están retraídos, no impidan que la puerta ruede libremente.
- Cuando el dispositivo anti pánico tiene que ser montado sobre puertas de dos hojas con dispositivos de cierre automáticos, hay que usar un dispositivo particular de coordinación de secuencia de cierre para permitir justamente la correcta secuencia del cierre de las puertas.
- El dispositivo non es idóneo para puertas con aplicaciones a enfilar.
- Para aplicaciones sobre puertas de cristal es esencial que este sea laminado/tratado
- Ningún dispositivo que permita de bloquear la puerta en la posición de cierre, se puede usar sin ser los establecidos por esta norma europea. Sin embargo, no está excluida la posibilidad de instalar dispositivos de cierre automáticos

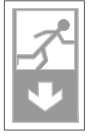

- Una señal que indique “pulsar la barra para abrir” o un pictograma (según figura a lado) tiene que ser puesto sobre la parte interior de la puerta arriba de la narra de accionamiento o sobre la barra misma en caso su superficie plana lo permita

- Es dispositivo está ensayado para la resistencia al fuego: la resistencia mínima es de 90 minutos

El sistema de fijación respecta los requisitos de norma del párrafo 4.3 EN 1125:2008 (se hace referencia al resumen de ensayo SRP01713).

- en caso sea necesario un dispositivo de cierre para volver a poner la puerta en su posición de cierre, hay que hacer atención a no volver difícil la salida de niños, mayores u inválidos.

- Todas las bocchette o las placas de protección suministradas tienen que estar montadas para asegurar la conformidad a la norma EN 1125:2008. La validez de la certificación caduca en el momento que - el ejemplar está dañado - está sometido a incendio que puede haber alterado sus propiedades- no corresponde más a la documentación depositada (es. modificaciones y/o alteraciones por terceros).

- FAPIM s.p.a. es responsable exclusivamente en caso que el dispositivo montado esté compuesto solo por artículos Fapim OLTRE.

**3 – Recomendaciones para la mantención**

Se recomienda a los ocupantes o sus representantes de ejecutar los controles de mantención por los menos dos veces al año; el montador y es usuario, aun en referencia a cuanto escrito al art. 4 de decreto ministerial de 03/11/2004 para la seguridad en caso de incendio, tienen que registrar las operaciones efectuadas en el cuadro arriba detallado:

- A) Controlar y accionar el anti pánico y asegurarse que todos los componentes se encuentren en buen estado de funcionamiento. En particular contralar que los tornillos estén bien fijados.
- B) Controlar que la bocchetta o le bocchette no tengan obstrucciones.
- C) Controlar que las superficies de contacto de los pestillos y bocchette estén bien lubricadas. En caso de necesidad lubricar con grasa como TecnoLube Seal SYNTHY HTL GREASE 5500 o equivalente que tenga una temperatura de empleo y viscosidad adecuadas para las condiciones de uso.
- D) Averiguar que no haya dispositivos de cierres suplementarios respecto a la instalación original;
- E) Controlar periódicamente que todos los componentes del sistema estén correctos de acuerdos al listado de los componentes suministrado al origen;
- F) Controlar periódicamente que el elemento operativo esté cerrado correctamente y, usando un dispositivo para medir, averiguar la fuerza necesaria para abrir la puerta. Averiguar aun que las fuerzas de accionamiento no hayan variado mucho respecto a aquellas registradas tras la primera instalación

Se puede descargar la declaración de prestación – DoP – al a página web [www.fapim.it](http://www.fapim.it) a la sección “certificaciones de producto”.

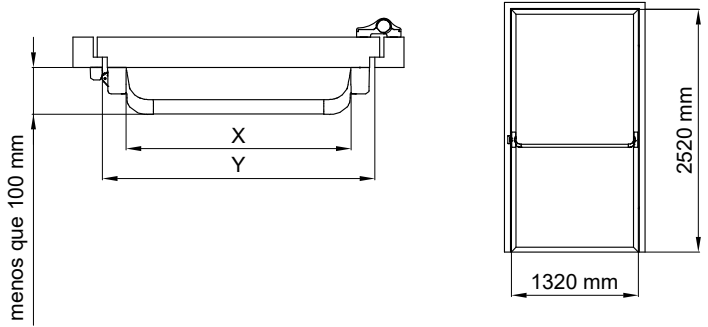

INCREMENTO PRESTAZIONI SPECIFICATE NEL REPORT  
0050/DC/AEF/22\_2 del 30/11/2022 SECONDO IL REGOLAMENTO  
"001/20 REGOLE PARTICOLARI ACCESSORI PER SERRAMENTI"  
DELL'ORGANISMO DI CERTIFICAZIONE CSI

L'incremento di prestazioni ottenuto tramite test relativo al report di cui sopra è inteso per le seguenti caratteristiche:

- Durabilità = 500.000 cicli
- Altezza anta = max. 3500mm
- Larghezza anta = max. 1600mm
- Intervallo temperatura di esercizio = da -20°C a + 100°C
- Resistenza alla corrosione = grado 5 (480h nebbia salina neutra)
- Resistenza al fuoco = EI 90

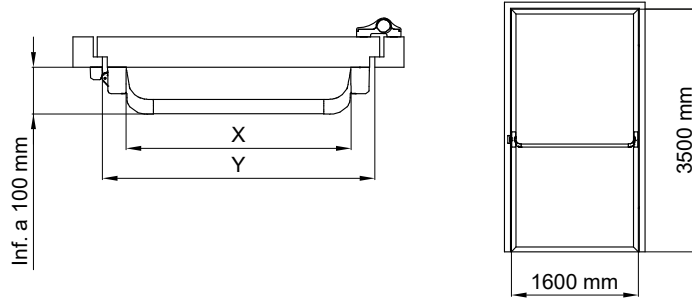

IT - IMPORTANTE

L'incremento delle prestazioni indicato, NON rientra nella certificazione CE del dispositivo, ma si riferisce solo ed esclusivamente alla certificazione volontaria secondo il documento "001/20" rilasciato dall'organismo di certificazione CSI, come sopra indicato.

PERFORMANCE INCREASE SPECIFIED IN THE REPORT  
0050/DC/AEF/22\_2 dated 11/30/2022 ACCORDING TO THE REGULATION  
"001/20 SPECIAL RULES ACCESSORIES FOR WINDOWS "  
OF THE CSI CERTIFICATION BODY

The performance boost obtained by testing the above report is intended for the following characteristics:

- Durability = 500,000 cycles
- Leaf height = max. 3500mm
- Leaf width = max. 1600mm
- Operating temperature range = -20°C to +100°C
- Corrosion resistance = grade 5 (480h neutral salt spray)
- Fire resistance = EI 90

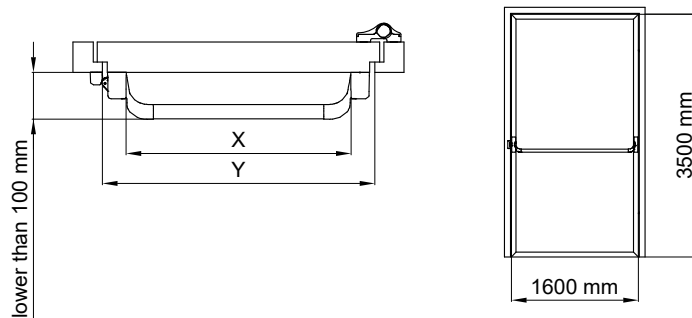

EN - IMPORTANT

The performance increase indicated does NOT fall within the CE certification of the device, but refers solely and exclusively to the voluntary certification according to "001/20" document issued by the "CSI" certification body, as indicated above.

L'amélioration des performances obtenue en testant le rapport ci-dessus est destinée aux caractéristiques suivantes :

- Durabilité = 500 000 cycles
- Hauteur du vantail = max. 3500mm
- Largeur vantail = max. 1600mm
- Plage de température de fonctionnement = -20°C à +100°C
- Résistance à la corrosion = grade 5 (480h brouillard salin neutre)
- Résistance au feu = EI 90

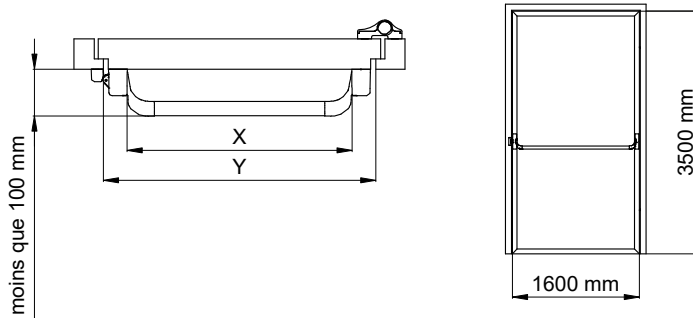

FR - IMPORTANT

L'augmentation des performances indiquée ne relève PAS de la certification CE de l'appareil, mais se réfère uniquement et exclusivement à la certification volontaire selon le document "001/20" délivré par l'organisme de certification "CSI", comme indiqué ci-dessus.





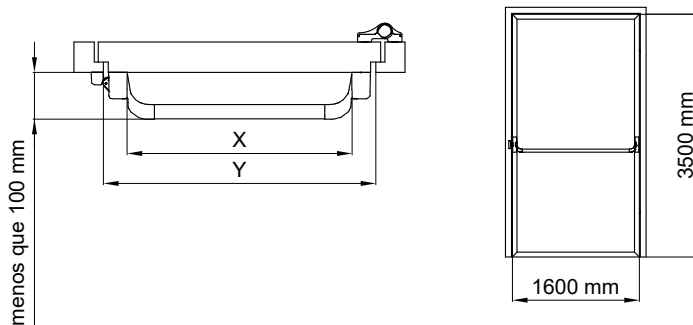





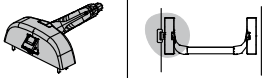

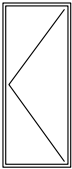

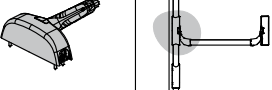

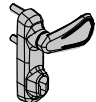
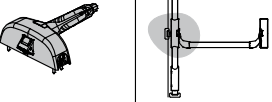

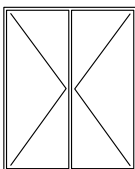



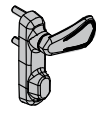
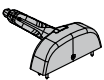

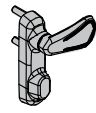

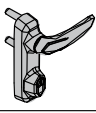



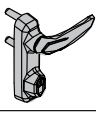

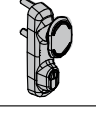

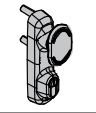
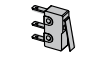

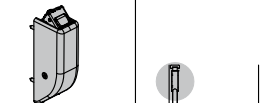

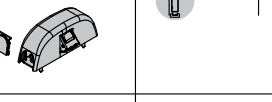

El aumento de rendimiento obtenido al probar el informe anterior está destinado a las siguientes características:

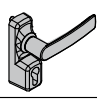
- Durabilidad = 500.000 ciclos
- Altura de la hoja = máx. 3500 mm
- Ancho de hoja = máx. 1600 mm
- Rango de temperatura de funcionamiento = -20°C a +100°C
- Resistencia a la corrosión = grado 5 (480h niebla salina neutral)
- Resistencia al fuego = EI 90

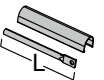
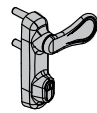

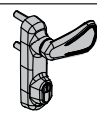
ES - IMPORTANTE

El aumento de rendimiento indicado NO está dentro de la certificación CE del dispositivo, sino que se refiere única y exclusivamente a la certificación voluntaria según el documento "001/20" emitido por el organismo de certificación "CSI", como se indica anteriormente.

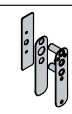
			8016			8500A			8571A	
			8023			8503A			8572A	
			8036			8505A			8520	
			8039A			8508			8525A	8573A
			8041			8520A			8504FA	8574A
			8101			8504X		8526A	8575A	
	L=830		8106			8527A		8529A	8577A	
	L=1130		8106X		8545		8540XA	8580A		
	L=1430		8116		8542XA		8544	8585A		
			8170A		8544		8567	8590A		
			8416		8567		8568A	8590B		
			8436		8568A 8568AS		8568B	8594A		
	L=950		8451		8568B 8568BS		8594A	8594B		
	L=1365		8453		8569A		8594B	8594C		
	L=2300		8455		8570A		8594C	8595		
			8480A				8595	8595A		

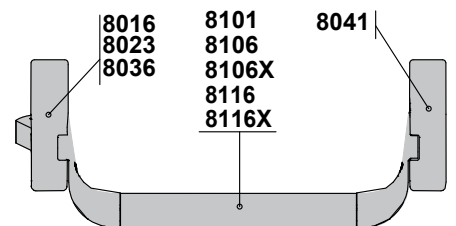
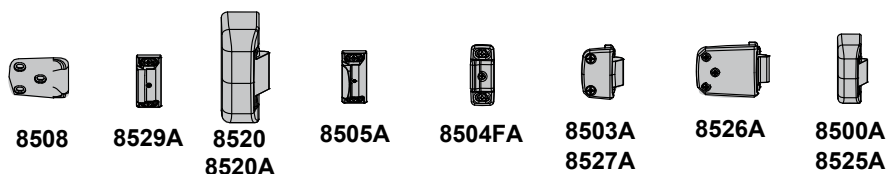

Per la composizione dei kit si rimanda al sito web <https://catalogo.fapim.it>  
 For the composition of the kit please refer to the website <https://catalogo.fapim.it>  
 Pour la composition des kits veuillez consulter le site Web <https://catalogo.fapim.it>  
 Para la composición de los kits consultar el sitio web <https://catalogo.fapim.it>



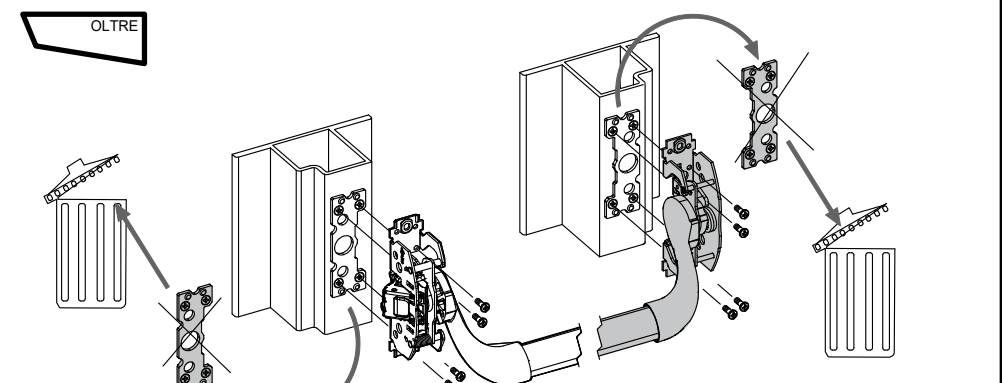
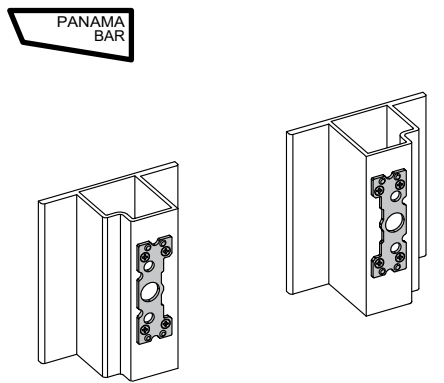
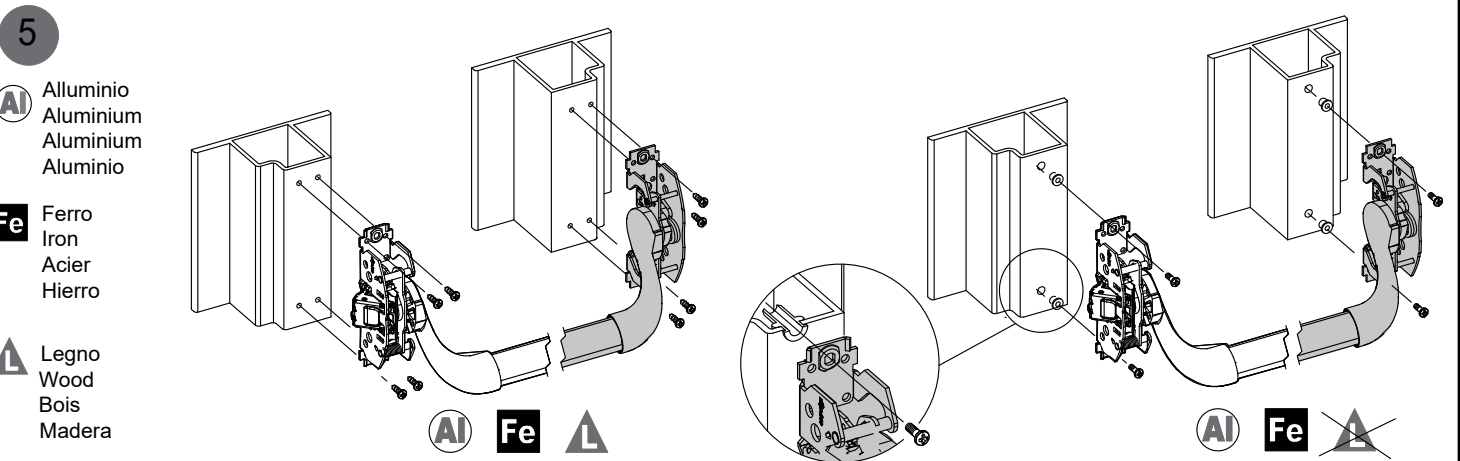
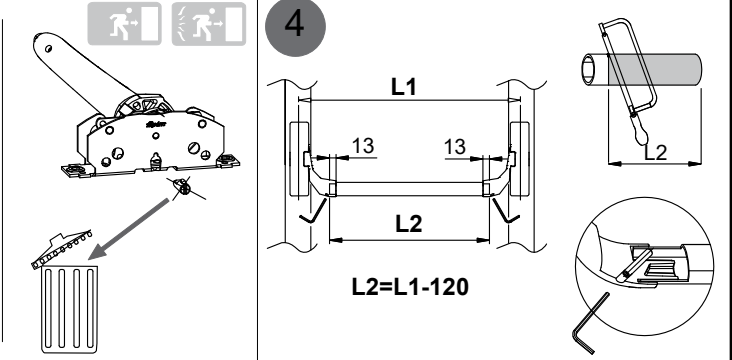
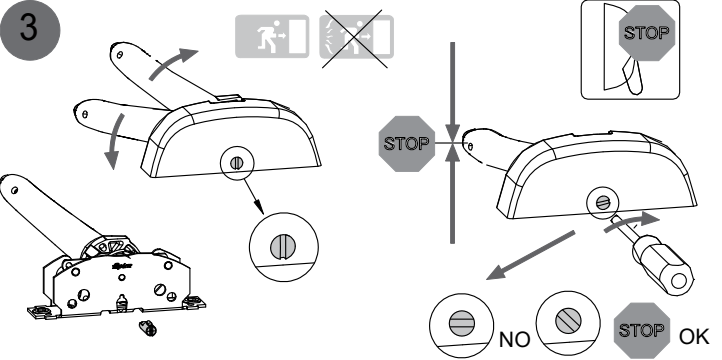
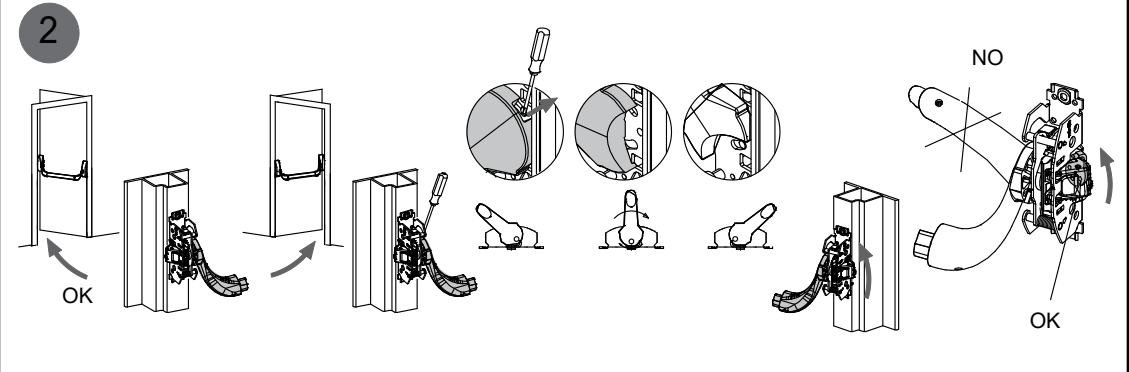
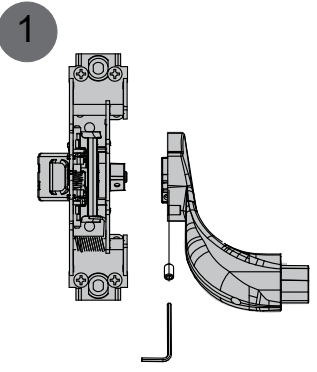
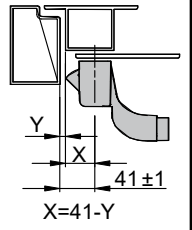
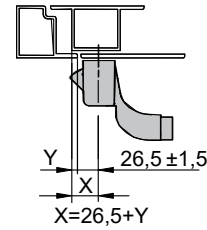
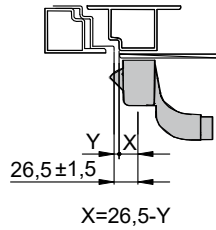
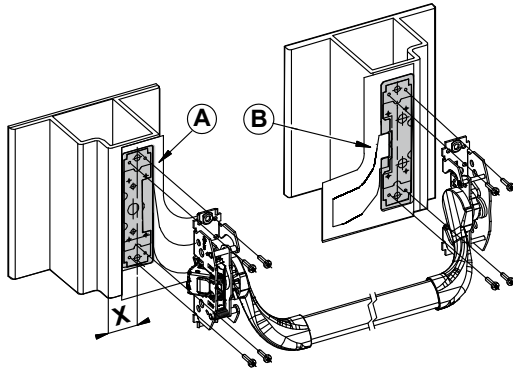
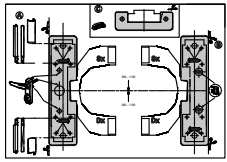

6

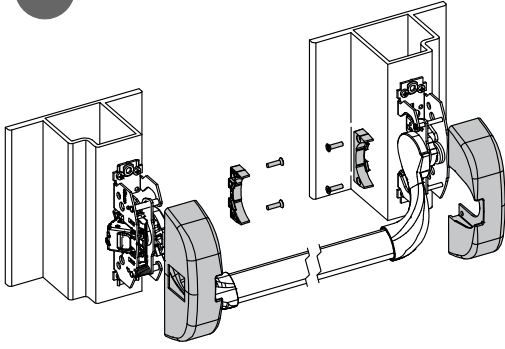

- L'impegno dello scrocco nell'incontro NON deve essere inferiore di 6 mm per qualunque configurazione. Lo scrocco esce dalla cuffia per una quota NON inferiore a 10 mm per qualunque configurazione.

- The use of the latch in the keeper HAS NOT to be less f 6mm for any configuration. The latch goes out from the covering part for a measure NOT less of 10mm for any configuration.

- L'utilise du pêne de la gâche NE doit pas être inferieure à 6mm pour n'importe quelle configuration. Le pêne dépasse la boite pour une mesure PAS inferieure à 10mm pour n'importe quelle configuration.

- El uso del pestillo en el cerradero NO tiene que ser inferito a 6 mm para cualquier configuración. El pestillo sale del cofre por una cota NO inferior a 10 mm para cualquier configuración.

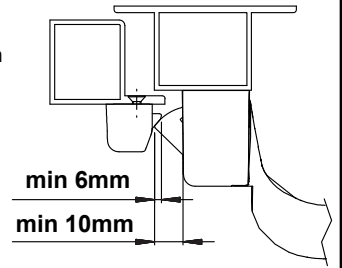

7

Art. 8500A

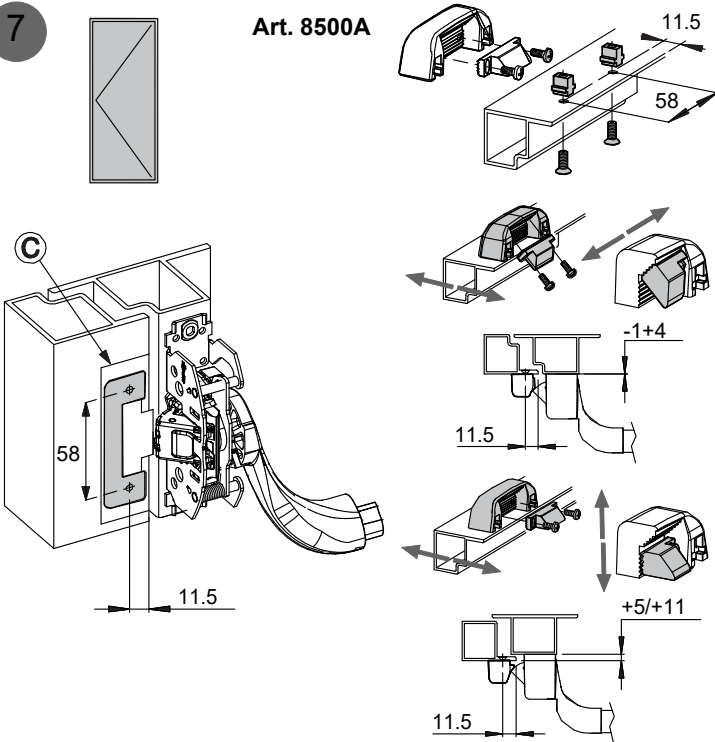

Art. 8505A

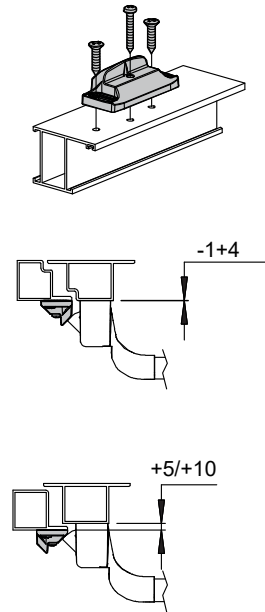

Art. 8503A

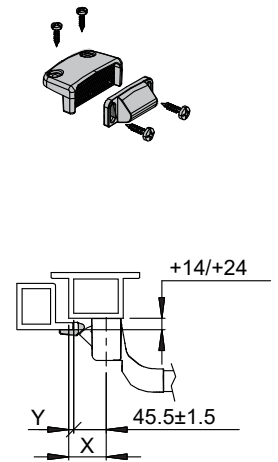

Art. 8525A

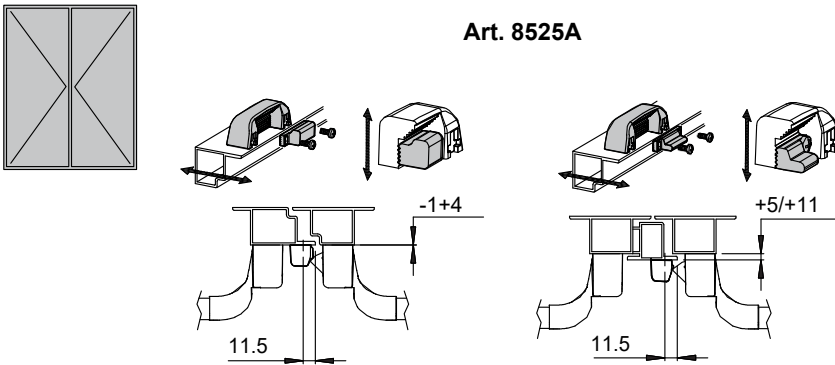

Art. 8526A

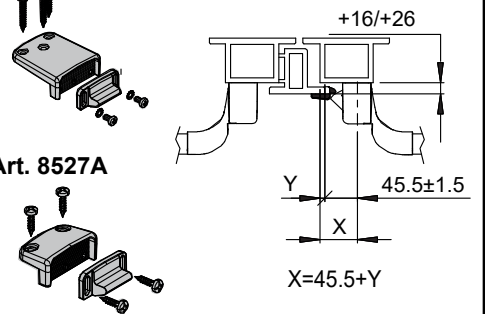

Art. 8504FA

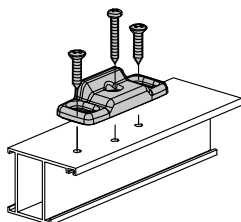

Art. 8529A

