

Product Data Sheet

Description:

HS 330

The cam lock HS 330 is suitable for letterboxes from RENZ manufactured from 1980.

- Includes 2 keys
- Material: stainless steel and stainless steel cap
- With clip for mounting
- Keyed different

Illustration:



Technical Details:

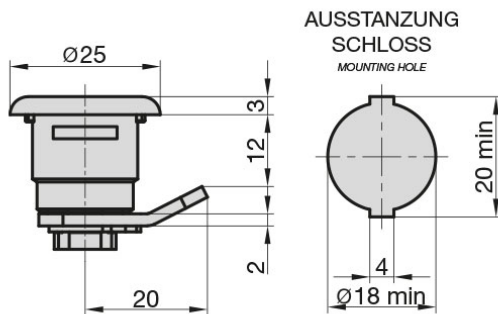

Details:

Order no.
9000-1330
Weight
51 g
Pricegroup
14
EAN
 4 026434 070699

Konstantinstraße 387
41238 Mönchengladbach
Germany

Tel. +49 (0) 21 66 / 98 56-0
Fax +49 (0) 21 66 / 98 56-55

info@basi.eu
www.basi.eu

Alles in Sicherheit

